

SPECIFICATIONS

HX300 L

ENGINE			
Maker / Model	Cummins QSB6.7		
Type	4-cycle turbocharged, charge air cooled diesel engine		
Rated flywheel horse power	SAE	J1995 (gross)	180 kW (242 HP) at 1,950 rpm
		J1349 (net)	171 kW (230 HP) at 1,950 rpm
	DIN	6271/1 (gross)	180 kW (245 PS) at 1,950 rpm
		6271/1 (net)	171 kW (233 PS) at 1,950 rpm
Max. torque	100.9 kgf·m (729.8 lbf·ft) at 1,500 rpm		
Bore × stroke	107 × 124 mm (4.21" × 4.88")		
Piston displacement	6,700 cc (409 cu in)		
Batteries	2 × 12 V × 160 Ah		
Starting motor	Denso 24 V - 4.8 kW		
Alternator	Denso 24 V - 95 A		

HYDRAULIC SYSTEM	
MAIN PUMP	
Type	Variable displacement tandem axis piston pumps
Max. flow	2 × 273 ℓ/min (72.1 U.S. gpm / 60.1 U.K. gpm)
Sub-pump for pilot circuit	Gear pump
Cross-sensing and fuel saving pump system	

HYDRAULIC MOTORS	
Travel	Variable displacement axial piston motor
Swing	Axial piston motor

RELIEF VALVE SETTING	
Implement circuits	350 kgf/cm ² (4,980 psi)
Travel	350 kgf/cm ² (4,980 psi)
Power boost (boom, arm, bucket)	380 kgf/cm ² (5,400 psi)
Swing circuit	300 kgf/cm ² (4,270 psi)
Pilot circuit	40 kgf/cm ² (570 psi)
Service valve	Installed

HYDRAULIC CYLINDERS	
No. of cylinder bore × stroke	Boom: Ø 140 × 1,465 mm
	Arm: Ø 150 × 1,765 mm
	Bucket: Ø 135 × 1,185 mm

DRIVES & BRAKES	
Drive method	Fully hydrostatic type
Drive motor	Axial piston motor, in-shoe design
Reduction system	Planetary reduction gear
Max. drawbar pull	26,500 kgf (58,400 lbf)
Max. travel speed (high / low)	5.9 km/hr (3.67 mph) / 3.3 km/hr (2.05 mph)
Gradeability	35° (70%)
Parking brake	Multi wet disc

CONTROL	
Pilot pressure operated joysticks and pedals with detachable lever provide almost effortless and fatigueless operation.	
Pilot control	Two joysticks with one safety lever (LH): Swing and arm (RH): Boom and bucket (ISO)
Traveling and steering	Two levers with pedals
Engine throttle	Electric, Dial type

SWING SYSTEM	
Swing motor	Fixed displacement axial piston motor
Swing reduction	Planetary gear reduction
Swing bearing lubrication	Grease-bathed
Swing brake	Multi wet disc
Swing speed	10.2 rpm

SERVICE REFILL CAPACITIES			
Re-filling	liter	US gal	UK gal
Fuel tank	500	132.1	110.0
Engine coolant	40	10.6	8.8
Engine oil	23	6.1	5.1
Swing device	11	2.9	2.4
Final drive (each)	7.8	2.06	1.72
Hydraulic system (including tank)	330	87	72.6
Hydraulic tank	190	50	41.8
DEF/AdBlue®	42.5	11.2	9.3

UNDERCARRIAGE

The X-leg type center frame is integrally welded with reinforced box-section track frames. The undercarriage includes lubricated rollers, idlers, track adjusters with shock absorbing springs and sprockets and a track chain with double or triple grouser shoes.

Center frame	X - leg type
Track frame	Pentagonal box type
No. of shoes on each side	48 EA
No. of carrier roller on each side	2 EA
No. of track roller on each side	9 EA
No. of rail guard on each side	2 EA

OPERATING WEIGHT (APPROXIMATE)

Operating weight, including 6,250 mm (20' 6") boom; 3,050 mm (10' 0") arm; SAE heaped 1.27 m³ (1.66 yd³) bucket, lubricant, coolant, full fuel tank, full hydraulic tank and all standard equipments.

OPERATING WEIGHT			
Shoes	Operating weight		Ground pressure
Type	Width mm (in)	kg (lb)	kgf / cm ² (psi)
Triple grouser	600 (24")	HX300 L	30,200 (66,580) 0.58 (8.25)
		HX300 L 2-piece boom	33,210 (73,216) 0.64 (9.10)
		HX300 NL	30,000 (66,140) 0.58 (8.25)
	700 (28")	HX300 NL 2-piece boom	30,010 (72,775) 0.64 (9.10)
		HX300 HW	33,040 (72,840) 0.64 (9.10)
		HX300 L	30,770 (67,840) 0.51 (7.25)
800 (32")	HX300 L 2-piece boom	33,780 (74,472) 0.56 (0.76)	
	HX300 HW	33,610 (74,100) 0.56 (7.95)	
	HX300 L	31,150 (68,670) 0.45 (6.40)	
900 (36")	HX300 L 2-piece boom	34,160 (75,310) 0.49 (0.97)	
	HX300 HW	33,990 (74,940) 0.49 (6.97)	
	HX300 L	31,530 (69,510) 0.41 (5.83)	
Double grouser	710 (28")	HX300 L 2-piece boom	34,540 (76,148) 0.44 (6.26)
		HX300 L	31,680 (69,840) 0.52 (7.39)
		HX300 HW	34,520 (76,100) 0.56 (7.96)

BUCKET SELECTION GUIDE HX300 L & DIGGING FORCE

BUCKETS

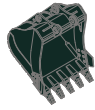

SAE heaped
m³ (yd³)

1.27 (1.66)
1.50 (1.96)

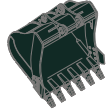

1.73 (2.26)
1.85 (2.42)

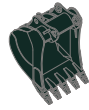

◆ 1.27 (1.66)
◆ 1.46 (1.91)

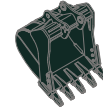

◆ 1.33 (1.74)
◆ 1.50 (1.96)



★ 0.52 (0.68)

Capacity m ³ (yd ³)		Width mm (in)		Weight kg (lb)	Recommendation mm (ft.in)							
					6,250 (20' 6") Boom				6,250 (20' 6") 2-Piece Boom			10,200 (33' 6") Boom
SAE heaped	CECE heaped	Without side cutters	With side cutters		2,100 (6' 11") Arm	2,500 (8' 2") Arm	3,050 (10' 0") Arm	3,750 (12' 4") Arm	2,100 (6' 11") Arm	2,500 (8' 2") Arm	3,050 (10' 0") Arm	7,850 (25' 9") Arm
1.27 (1.66)	1.11 (1.45)	1,325 (52.2)	1,410 (55.5)	1,100 (2,430)	●	●	●	⊙	●	●	●	-
1.50 (1.96)	1.30 (1.70)	1,515 (59.6)	1,600 (63.0)	1,180 (2,600)	●	●	⊙	○	●	●	●	-
1.73 (2.26)	1.51 (1.98)	1,605 (63.2)	1,690 (66.5)	1,280 (2,820)	⊙	⊙	○	○	●	●	⊙	-
1.85 (2.42)	1.61 (2.11)	1,700 (66.9)	1,780 (70.1)	1,330 (2,930)	⊙	○	○	○	●	⊙	⊙	-
◆ 1.27(1.66)	1.11 (1.45)	1,380 (54.3)	-	1,290 (2,840)	●	●	⊙	⊙	●	●	●	-
◆ 1.46(1.91)	1.28 (1.67)	1,535 (60.4)	-	1,380 (3,040)	⊙	⊙	⊙	○	●	●	●	-
◆ 1.33 (1.74)	1.16 (1.52)	1,420 (55.9)	-	1,470 (3,240)	⊙	⊙	⊙	○	●	●	●	-
◆ 1.50 (1.96)	1.30 (1.70)	1,550 (61.0)	-	1,550 (3,420)	⊙	⊙	●	○	●	●	⊙	-
★ 0.52(0.68)	0.45 (0.59)	945 (37.2)	1,020 (40.2)	460 (1,010)	-	-	-	-	-	-	-	⊙

- ◆ Heavy duty bucket
- ◆ Rock-Heavy duty bucket
- ★ Long reach bucket

- : Applicable for materials with density of 2,000 kg/m³ (3,370 lb/yd³) or less
- ⊙ : Applicable for materials with density of 1,600 kg/m³ (2,700 lb/yd³) or less
- : Applicable for materials with density of 1,100 kg/m³ (1,850 lb/yd³) or less

ATTACHMENT

Booms and arms are welded with a low-stress, full-box section design. 6.25 m (20' 6"); 10.2 m (33' 6") Booms and 6.25 m (20' 6") 2-Piece Boom and 2.1 m (6' 11"); 2.5 m (8' 2"); 3.05 m (10' 0"); 3.75 m (12' 4") & 7.85 m (25' 9") Arms are available.

DIGGING FORCE

Boom	Length	mm (ft.in)	6,250 (20' 6")					10,200 (33' 6")	Remarks:
	Weight	kg (lb)	2,670 (5,900)					3,420 (7,540)	
Arm	Length	mm (ft.in)	2,100 (6' 11")	2,500 (8' 2")	3,050 (10' 0")	3,750 (12' 4")	7,850 (25' 9")	[]: Power Boost	
	Weight	kg (lb)	1,480 (3,260)	1,460 (3,220)	1,570 (3,460)	1,710 (3,770)	1,690 (3,730)		
Bucket digging force	SAE	kN	168.7 [183.1]	168.7 [183.1]	168.7 [183.1]	168.7 [183.1]	70		
		kgf	17200 [18670]	17200 [18670]	17200 [18670]	17200 [18670]	7100		
		lbf	37920 [41170]	37920 [41170]	37920 [41170]	37920 [41170]	15650		
	ISO	kN	192.2 [208.7]	192.2 [208.7]	192.2 [208.7]	192.2 [208.7]	80		
		kgf	19600 [21280]	19600 [21280]	19600 [21280]	19600 [21280]	8200		
		lbf	43210 [46910]	43210 [46910]	43210 [46910]	43210 [46910]	18080		
Arm crowd force	SAE	kN	180.4 [195.9]	156.9 [170.4]	131.4 [142.7]	114.7 [124.6]	47.1		
		kgf	18400 [19980]	16000 [17370]	13400 [14550]	11700 [12700]	4800		
		lbf	40570 [44050]	35270 [38290]	29540 [32070]	25790 [28000]	10580		
	ISO	kN	190.3 [206.6]	163.8 [177.8]	136.3 [148.0]	119.6 [129.9]	48.1		
		kgf	19400 [21060]	16700 [18130]	13900 [15090]	12200 [13250]	4900		
		lbf	42770 [46440]	36820 [39980]	30640 [33270]	26900 [29210]	10800		

Note : Boom weight includes arm cylinder, piping, and pin
Arm weight includes bucket cylinder, linkage, and pin

DIMENSIONS & WORKING RANGE

HX300 L

HX300 L / HX300 NL DIMENSIONS

6.25 m (20' 6") BOOM and 2.1 m (6' 11"); 2.5 m (8' 2"); 3.05 m (10' 0") & 3.75 m (12' 4") ARM

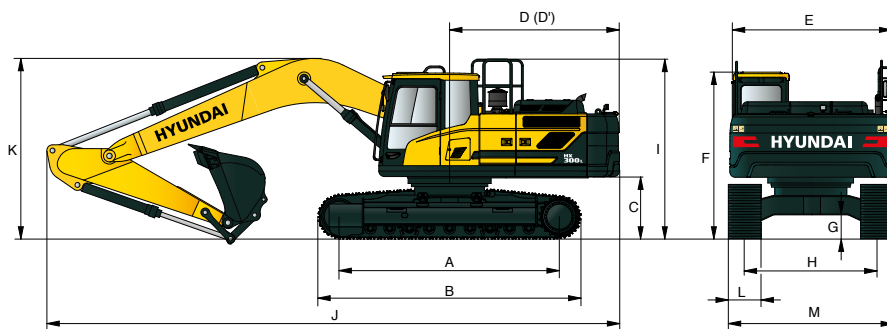

Unit : mm (ft-in)

A	Tumbler distance	4,030 (13' 3")
B	Overall length of crawler	4,880 (16' 0")
C	Ground clearance of counterweight	1,185 (3' 9")
D	Tail swing radius	3,210 (10' 5")
D'	Rear-end length	3,120 (10' 3")
E	Overall width of upperstructure	2,980 (9' 9")
F	Overall height of cab	3,130 (10' 3")
G	Min. ground clearance	500 (1' 8")
H	Track gauge	HX300 L 2,600 (8' 6") HX300 NL 2,390 (7' 10")
I	Overall height of guardrail	3,335 (10' 9")

Boom length		6,250 (20' 6")					
Arm length		2,100 (6' 11")	2,500 (8' 2")	3,050 (10' 0")	3,750 (12' 4")		
J	Overall length	10,700 (35' 1")	10,650 (34' 11")	10,560 (34' 8")	10,630 (34' 11")		
K	Overall height of boom	3,590 (11' 9")	3,470 (11' 5")	3,290 (10' 10")	3,500 (11' 6")		
L	Track shoe	Type	Triple grouser			Double grouser	
		width	600 (24")	700 (28")	800 (32")	900 (36")	700 (28")
M	Overall width	HX300 L	3,200 (10' 6")	3,300 (10' 10")	3,400 (11' 1")	3,500 (11' 5")	3,300 (10' 10")
		HX300 NL	2,990 (9' 10")				

HX300 L / HX300 NL WORKING RANGE

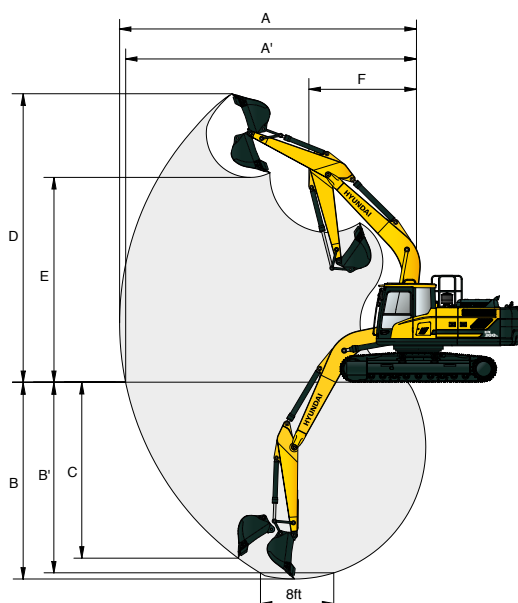

Unit : mm (ft-in)

Boom length		6,250 (20' 6")			
Arm length		2,100 (6' 11")	2,500 (8' 2")	3,050 (10' 0")	3,750 (12' 4")
A	Max. digging reach	10,020 (32' 10")	10,280 (33' 9")	10,820 (35' 6")	11,400 (37' 5")
A'	Max. digging reach on ground	9,820 (32' 3")	10,080 (33' 1")	10,620 (34' 10")	11,220 (36' 10")
B	Max. digging depth	6,440 (21' 2")	6,840 (22' 5")	7,390 (24' 3")	8,090 (26' 7")
B'	Max. digging depth (8' level)	6,240 (20' 6")	6,630 (21' 9")	7,200 (23' 7")	7,920 (26' 0")
C	Max. vertical wall digging depth	6,000 (19' 8")	5,850 (19' 2")	6,380 (20' 11")	7,080 (23' 3")
D	Max. digging height	10,040 (32' 11")	10,000 (32' 10")	10,160 (33' 4")	10,360 (34' 0")
E	Max. dumping height	6,940 (22' 9")	7,030 (23' 1")	7,110 (23' 4")	7,310 (24' 0")
F	Min. front swing radius	4,400 (14' 5")	4,300 (14' 1")	4,250 (13' 11")	4,200 (13' 9")

DIMENSIONS & WORKING RANGE

HX300 L

HX300 L LONG REACH

10.2 m (33' 6") BOOM and 7.85 m (25' 9") ARM

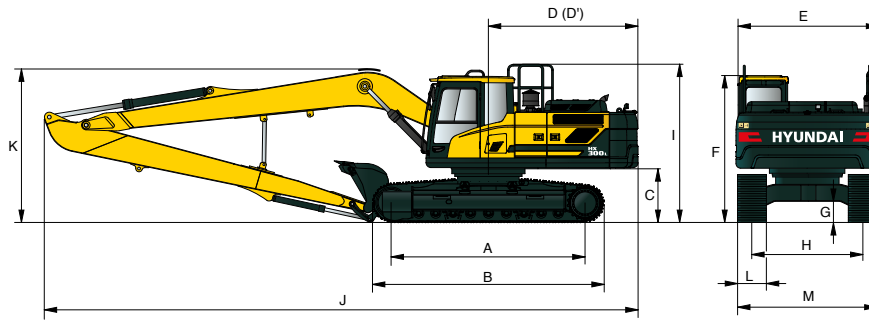

Unit : mm (ft-in)

A	Tumbler distance	4,030 (13' 3")
B	Overall length of crawler	4,880 (16' 0")
C	Ground clearance of counterweight	1,185 (3' 9")
D	Tail swing radius	3,210 (10' 5")
D'	Rear-end length	3,120 (10' 3")
E	Overall width of upperstructure	2,980 (9' 9")
F	Overall height of cab	3,130 (10' 3")
G	Min. ground clearance	500 (1' 8")
H	Track gauge	2,600 (8' 6")
I	Overall height of guardrail	3,335 (10' 9")

	Boom length	10,200 (33' 6")
	Arm length	7,850 (25' 9")
J	Overall length	14,560 (47' 9")
K	Overall height of boom	3,560 (11' 8")
L	Track shoe width	800 (31' 5")
M	Overall width	3,400 (11' 2")

HX300 L LONG REACH WORKING RANGE

Unit : mm (ft-in)

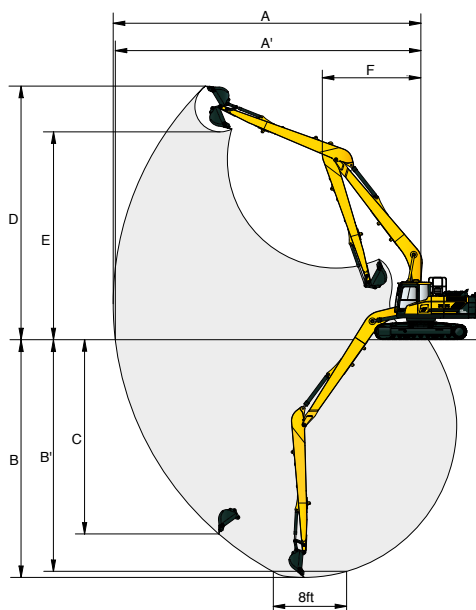

	Boom length	10,200 (33' 6")
	Arm length	7,850 (25' 9")
A	Max. digging reach	18,510 (60' 9")
A'	Max. digging reach on ground	18,400 (60' 4")
B	Max. digging depth	14,820 (48' 7")
B'	Max. digging depth (8' level)	14,690 (48' 2")
C	Max. vertical wall digging depth	12,020 (39' 5")
D	Max. digging height	14,500 (47' 7")
E	Max. dumping height	12,190 (40' 0")
F	Min. front swing radius	6,250 (20' 6")

DIMENSIONS & WORKING RANGE

HX300 L

HX300 L HIGH WALKER DIMENSIONS

6.25 m (20' 6") BOOM and 2.1 m (6' 11"); 2.5 m (8' 2"); 3.05 m (10' 0") & 3.75 m (12' 4") ARM

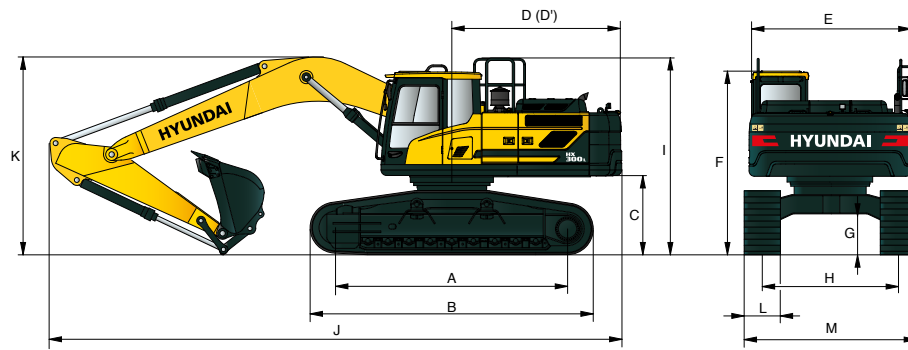

Unit : mm (ft-in)

A	Tumbler distance	4,030 (13' 3")
B	Overall length of crawler	4,880 (16' 0")
C	Ground clearance of counterweight	1,490 (4' 9")
D	Tail swing radius	3,210 (10' 5")
D'	Rear-end length	3,120 (10' 3")
E	Overall width of upperstructure	2,980 (9' 9")
F	Overall height of cab	3,430 (11' 9")
G	Min. ground clearance	765 (2' 6")
H	Track gauge	2,870 (9' 5")
I	Overall height of guardrail	3,640 (11' 9")

Boom length		6,250 (20' 6")			
Arm length		2,100 (6' 11")	2,500 (8' 2")	3,050 (10' 0")	3,750 (12' 4")
J Overall length		10,690 (35' 1")	10,610 (34' 10")	10,430 (34' 3")	10,530 (34' 7")
K Overall height of boom		3,740 (12' 3")	3,590 (11' 9")	3,350 (11' 0")	3,510 (11' 6")
L Track shoe	Type	Triple grouser			Double grouser
	width	600 (24")	700 (28")	800 (32")	700 (28")
M Overall width		3,470 (11' 5")	3,570 (11' 9")	3,670 (12' 0")	3,570 (11' 9")

HX300 L HIGH WALKER WORKING RANGE

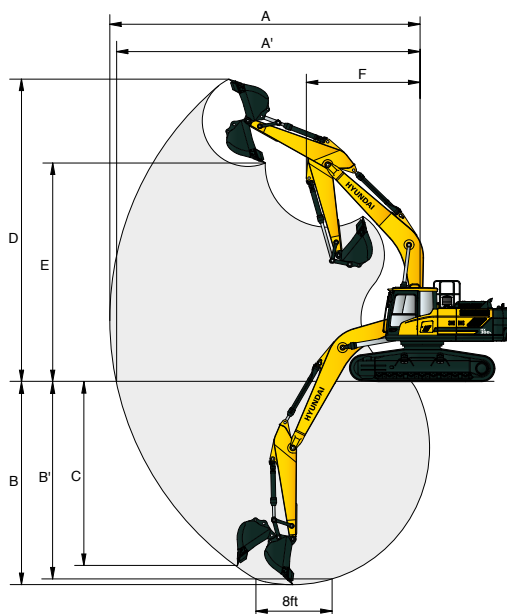

Unit : mm (ft-in)

Boom length		6,250 (20' 6")			
Arm length		2,100 (6' 11")	2,500 (8' 2")	3,050 (10' 0")	3,750 (12' 4")
A	Max. digging reach	10,020 (32' 10")	10,280 (33' 9")	10,790 (35' 5")	11,400 (37' 5")
A'	Max. digging reach on ground	9,750 (32' 0")	10,020 (32' 10")	10,530 (34' 7")	11,160 (36' 7")
B	Max. digging depth	6,140 (20' 2")	6,540 (21' 5")	7,090 (23' 3")	7,790 (25' 7")
B'	Max. digging depth (8' level)	5,930 (19' 5")	6,330 (20' 9")	6,910 (22' 8")	7,630 (25' 0")
C	Max. vertical wall digging depth	5,700 (18' 8")	5,560 (18' 3")	6,090 (20' 0")	6,790 (22' 3")
D	Max. digging height	10,320 (33' 10")	10,270 (33' 8")	10,440 (34' 3")	10,660 (35' 0")
E	Max. dumping height	7,240 (23' 9")	7,170 (23' 6")	7,400 (24' 3")	7,610 (25' 0")
F	Min. front swing radius	4,400 (14' 5")	4,300 (14' 1")	4,250 (13' 11")	4,200 (13' 9")

DIMENSIONS & WORKING RANGE

HX300 L

HX300 L 2-PIECE BOOM DIMENSIONS

6.25 m (20' 6") 2-Piece BOOM and 2.1 m (6' 11"); 2.5 m (8' 2"); 3.05 m (10' 0") & 3.75 m (12' 4") ARM

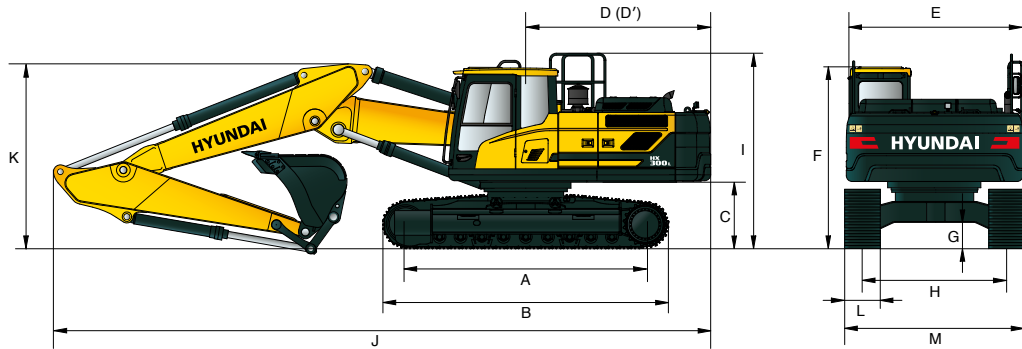

Unit : mm (ft-in)

A	Tumbler distance	4,030 (13' 3")
B	Overall length of crawler	4,880 (16' 0")
C	Ground clearance of counterweight	1,490 (4' 9")
D	Tail swing radius	3,210 (10' 5")
D'	Rear-end length	3,120 (10' 3")
E	Overall width of upperstructure	2,980 (9' 9")
F	Overall height of cab	3,130 (10' 3")
G	Min. ground clearance	765 (2' 6")
H	Track gauge	2,870 (9' 5")
I	Overall height of guardrail	3,335 (10' 9")

Boom length	6,250 (20' 6")				
Arm length	2,100 (6' 11")	2,500 (8' 2")	3,050 (10' 0")	3,750 (12' 4")	
J Overall length	10,720 (35' 2")	10,680 (35' 1")	10,640 (34' 11")	10,650 (34' 11")	
K Overall height of boom	3,460 (11' 4")	3,380 (11' 1")	3,270 (10' 9")	3,540 (11' 7")	
L Track shoe	Type	Triple grouser			Double grouser
	width	600 (24")	700 (28")	800 (32")	700 (28")
M Overall width	3,470 (11' 5")	3,570 (11' 9")	3,670 (12' 0")	3,570 (11' 9")	

HX300 L 2-PIECE BOOM WORKING RANGE

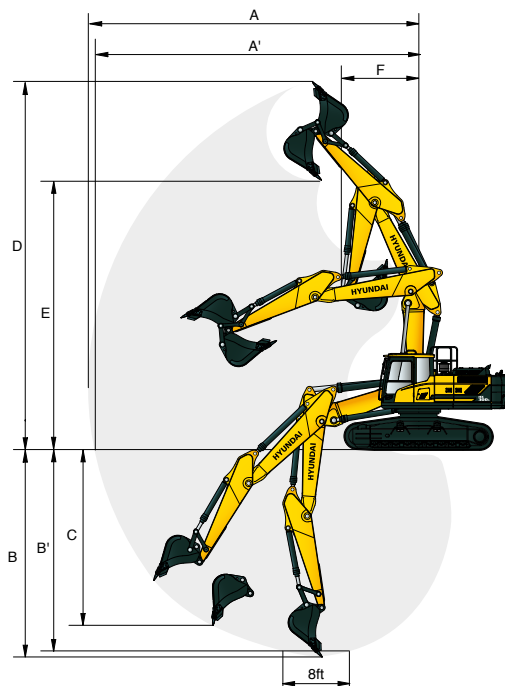



Unit : mm (ft-in)

Boom length	6,250 (20' 6")			
Arm length	2,100 (6' 11")	2,500 (8' 2")	3,050 (10' 0")	3,750 (12' 4")
A Max. digging reach	10,060 (32' 10")	10,340 (33' 9")	10,860 (35' 5")	11,480 (37' 5")
A' Max. digging reach on ground	9,850 (32' 0")	10,140 (32' 10")	10,670 (34' 7")	11,300 (36' 7")
B Max. digging depth	5,930 (20' 2")	6,280 (21' 5")	6,820 (23' 3")	7,490 (25' 7")
B' Max. digging depth (8° level)	5,930 (19' 5")	6,330 (20' 9")	6,910 (22' 8")	7,630 (25' 0")
C Max. vertical wall digging depth	5,010 (18' 8")	5,210 (18' 3")	5,780 (20' 0")	6,450 (22' 3")
D Max. digging height	11,540 (33' 10")	11,680 (33' 8")	12,090 (34' 3")	12,550 (35' 0")
E Max. dumping height	8,310 (23' 9")	8,440 (23' 6")	8,850 (24' 3")	9,320 (25' 0")
F Min. front swing radius	3,180 (14' 5")	2,900 (14' 1")	2,630 (13' 11")	2,850 (13' 9")











LIFTING CAPACITY

HX300 L











 Rating over-front  Rating over-side or 360 degrees

HX300 L













6.25 m (20' 6") boom; 2.10 m (6' 11") arm equipped with 1.27 m³ (SAE heaped) bucket and 600 mm (24") triple grouser shoes.

Load point height m (ft)	Load radius								At max. reach		Reach m (ft)
	3.0 m (10 ft)		4.5 m (15 ft)		6.0 m (20 ft)		7.5 m (25 ft)		Capacity		
											
7.5 m (25 ft)	kg				*7670	*7670			*7890	7410	6.40
	lb				*16910	*16910			*17390	16340	(21.0)
6.0 m (20 ft)	kg				*7900	*7900			*7790	5740	7.44
	lb				*17420	*17420			*17170	12650	(24.4)
4.5 m (15 ft)	kg				*8950	7830	*7930	5580	7640	4950	8.06
	lb				*19730	17260	*17480	12300	16840	10910	(26.5)
3.0 m (10 ft)	kg				*10270	7420	8420	5400	7100	4570	8.37
	lb				*22640	16360	18560	11900	15650	10080	(27.5)
1.5 m (5 ft)	kg				*11350	7110	8240	5230	6970	4470	8.40
	lb				*25020	15670	18170	11530	15370	9850	(27.6)
Ground Line	kg				11340	6950	8130	5140	7230	4610	8.16
	lb				25000	15320	17920	11330	15940	10160	(26.8)
-1.5 m (-5 ft)	kg		*15530	10610	11330	6940	8170	5170	8030	5100	7.60
	lb		*34240	23390	24980	15300	18010	11400	17700	11240	(24.9)
-3.0 m (-10 ft)	kg	*18440	*18440	*14030	10810	*10600	7090		*9060	6220	6.66
	lb	*40650	*40650	*30930	23830	*23370	15630		*19970	13710	(21.9)
-4.5 m (-15 ft)	kg		*10580	*10580					*8760	*8760	5.12
	lb		*23320	*23320					*19310	*19310	(16.8)

6.25 m (20' 6") boom; 2.50 m (8' 2") arm equipped with 1.27 m³ (SAE heaped) bucket and 600 mm (24") triple grouser shoes.

Load point height m (ft)	Load radius								At max. reach		Reach m (ft)
	3.0 m (10 ft)		4.5 m (15 ft)		6.0 m (20 ft)		7.5 m (25 ft)		Capacity		
											
7.5 m (25 ft)	kg				*6980	*6980			*6760	*6760	6.74
	lb				*15390	*15390			*14900	*14900	(22.1)
6.0 m (20 ft)	kg				*7380	*7380	*7170	5740	*6440	5430	7.74
	lb				*16270	*16270	*15810	12650	*14200	11970	(25.4)
4.5 m (15 ft)	kg		*10660	*10660	*8470	7900	*7530	5610	*6420	4710	8.34
	lb		*23500	*23500	*18670	17420	*16600	12370	*14150	10380	(27.4)
3.0 m (10 ft)	kg		*13720	11240	*9850	7470	*8180	5410	*6640	4360	8.64
	lb		*30250	24780	*21720	16470	*18030	11930	*14640	9610	(28.3)
1.5 m (5 ft)	kg				*11040	7120	8230	5220	6640	4250	8.67
	lb				*24340	15700	18140	11510	14640	9370	(28.4)
Ground Line	kg		*16170	10470	11310	6920	8100	5100	6850	4360	8.43
	lb		*35650	23080	24930	15260	17860	11240	15100	9610	(27.7)
-1.5 m (-5 ft)	kg	*11150	*11150	*15780	10490	11260	6870	8080	5090	7530	7.89
	lb	*24580	*24580	*34790	23130	24820	15150	17810	11220	16600	(25.9)
-3.0 m (-10 ft)	kg	*19830	*19830	*14550	10660	*10980	6980		*9000	5700	6.99
	lb	*43720	*43720	*32080	23500	*24210	15390		*19840	12570	(22.9)
-4.5 m (-15 ft)	kg	*15970	*15970	*11820	11040				*9210	8150	5.55
	lb	*35210	*35210	*26060	24340				*20300	17970	(18.2)

6.25 m (20' 6") boom; 3.05 m (10' 0") arm equipped with 1.27 m³ (SAE heaped) bucket and 600 mm (24") triple grouser shoes.

Load point height m (ft)	Load radius										At max. reach		Reach m (ft)		
	1.5 m (5 ft)		3.0 m (10 ft)		4.5 m (15 ft)		6.0 m (20 ft)		7.5 m (25 ft)		9.0 m (30 ft)			Capacity	
															
7.5 m (25 ft)	kg											*4410	*4410	7.38	
	lb											*9720	*9720	(24.2)	
6.0 m (20 ft)	kg							*6490	5820			*4220	*4220	8.30	
	lb							*14310	12830			*9300	*9300	(27.2)	
4.5 m (15 ft)	kg			*9450	*9450	*7760	*7760	*6980	5650			*4210	*4210	8.86	
	lb			*20830	*20830	*17110	*17110	*15390	12460			*9280	*9280	(29.1)	
3.0 m (10 ft)	kg			*12510	11510	*9210	7550	*7720	5430	*5490	4080	*4350	3980	9.14	
	lb			*27580	25380	*20300	16640	*17020	11970	*12100	8990	*9590	8770	(30.0)	
1.5 m (5 ft)	kg			*14900	10740	*10550	7150	8220	5210	*6190	3990	*4640	3870	9.17	
	lb			*32850	23680	*23260	15760	18120	11490	*13650	8800	*10230	8530	(30.1)	
Ground Line	kg			*15940	10420	11290	6890	8050	5060			*5160	3960	8.94	
	lb			*35140	22970	24890	15190	17750	11160			*11380	8730	(29.3)	
-1.5 m (-5 ft)	kg	*7650	*7650	*11100	*11100	*15950	10360	11170	6790	7980	4990	*6050	4270	8.44	
	lb	*16870	*16870	*24470	*24470	*35160	22840	24630	14970	17590	11000	*13340	9410	(27.7)	
-3.0 m (-10 ft)	kg	*13100	*13100	*17910	*17910	*15100	10470	11230	6830	8060	5060	*7770	4970	7.61	
	lb	*28880	*28880	*39480	*39480	*33290	23080	24760	15060	17770	11160	*17130	10960	(25.0)	
-4.5 m (-15 ft)	kg			*18100	*18100	*13040	10770	*9550	7070			*8810	6620	6.32	
	lb			*39900	*39900	*28750	23740	*21050	15590			*19420	14590	(20.7)	

1. Lifting capacity are based on SAE J1097 and ISO 10567.



2. Lifting capacity of the HX series does not exceed 75% of tipping load with the machine on firm, level ground or 87% of full hydraulic capacity.

3. The load point is a hook located on the back of the bucket.

4. (*) indicates load limited by hydraulic capacity.















LIFTING CAPACITY

HX300 L

 Rating over-front  Rating over-side or 360 degrees











HX300 L

6.25 m (20' 6") boom; 3.75 m (12' 4") arm equipped with 1.27 m³ (SAE heaped) bucket and 600 mm (24") triple grouser shoes.











Load point height m (ft)	Load radius										At max. reach					
	1.5 m (5 ft)		3.0 m (10 ft)		4.5 m (15 ft)		6.0 m (20 ft)		7.5 m (25 ft)		9.0 m (30 ft)		Capacity	Reach		
															m (ft)	
7.5 m (25 ft)	kg									*5120	*5120			*3490	*3490	8.14
	lb									*11290	11290			*7690	*7690	(26.7)
6.0 m (20 ft)	kg									*5700	*5700			*3370	*3370	8.97
	lb									*12570	12570			*7430	*7430	(29.4)
4.5 m (15 ft)	kg															
	lb									*6830	*6830	*6290	5730	*5230	4220	9.50
3.0 m (10 ft)	kg									*15060	*15060	*13870	12630	*11530	9300	(31.2)
	lb									*3340	7690	*7110	5480	6380	4100	9.76
1.5 m (5 ft)	kg									*10960	*10960	*13740	10950	*9850	7220	9.79
	lb									*24160	*24160	*30290	24140	*21720	15920	(32.1)
Ground Line	kg									*10980	6890	8030	5030	6120	3860	9.58
	lb									*24210	15190	17700	11090	13490	8510	(31.4)
-1.5 m (-5 ft)	kg	*7070	*7070	*10570	*10570	*15920	10250	11100	6720	7900	4910	*5710	3820	*4750	3760	9.11
	lb	*15590	*15590	*23300	*23300	*35100	22600	24470	14820	17420	10820	*12590	8420	*10470	8290	(29.9)
-3.0 m (-10 ft)	kg	*11090	*11090	*15460	*15460	*15540	10270	11080	6690	7900	4910			*5900	4270	8.35
	lb	*24450	*24450	*34080	*34080	*34260	22640	24430	14750	17420	10820			*13010	9410	(27.4)
-4.5 m (-15 ft)	kg	*15990	*15990	*20280	*20280	*14140	10480	*10510	6830					*8250	5350	7.19
	lb	*35250	*35250	*44710	*44710	*31170	23100	*23170	15060					*18190	11790	(23.6)

HX300 NL

6.25 m (20' 6") boom; 2.10 m (6' 11") arm equipped with 1.27 m³ (SAE heaped) bucket and 600 mm (24") triple grouser shoes.

Load point height m (ft)	Load radius								At max. reach			
	3.0 m (10 ft)		4.5 m (15 ft)		6.0 m (20 ft)		7.5 m (25 ft)		Capacity	Reach		
											m (ft)	
7.5 m (25 ft)	kg					*7690	7600			*7920	6780	6.40
	lb					*16950	16760			*17460	14950	(21.0)
6.0 m (20 ft)	kg					*7930	7480			*7810	5250	7.44
	lb					*17480	16490			*17220	11570	(24.4)
4.5 m (15 ft)	kg					*8980	7140	*7950	5100	7610	4520	8.06
	lb					*19800	15740	*17530	11240	16780	9960	(26.5)
3.0 m (10 ft)	kg					*10300	6750	8380	4930	7070	4170	8.37
	lb					*22710	14880	18470	10870	15590	9190	(27.5)
1.5 m (5 ft)	kg					*11390	6450	8200	4770	6940	4070	8.40
	lb					*25110	14220	18080	10520	15300	8970	(27.6)
Ground Line	kg					11290	6300	8100	4680	7200	4200	8.16
	lb					24890	13890	17860	10320	15870	9260	(26.8)
-1.5 m (-5 ft)	kg			*15560	9510	11280	6290	8130	4710	7990	4640	7.60
	lb			*34300	20970	24870	13870	17920	10380	17610	10230	(24.9)
-3.0 m (-10 ft)	kg	*18480	*18480	*14060	9700	*10630	6430			*9090	5650	6.66
	lb	*40740	*40740	*31000	21380	*23440	14180			*20040	12460	(21.9)
-4.5 m (-15 ft)	kg			*10610	10150					*8790	8490	5.12
	lb			*23390	22380					*19380	18720	(16.8)

6.25 m (20' 6") boom; 2.50 m (8' 2") arm equipped with 1.27 m³ (SAE heaped) bucket and 600 mm (24") triple grouser shoes.

Load point height m (ft)	Load radius								At max. reach			
	3.0 m (10 ft)		4.5 m (15 ft)		6.0 m (20 ft)		7.5 m (25 ft)		Capacity	Reach		
											m (ft)	
7.5 m (25 ft)	kg					*7020	*7020			*6800	6430	6.67
	lb					*15480	*15480			*14990	14180	(21.9)
6.0 m (20 ft)	kg					*7360	*7360			*6460	5040	7.68
	lb					*16230	*16230	*15870	11600	*14240	11110	(25.2)
4.5 m (15 ft)	kg			*10530	*10530	*8420	7240	*7520	5150	*6430	4350	8.30
	lb			*23210	*23210	*18560	15960	*16580	11350	*14180	9590	(27.2)
3.0 m (10 ft)	kg			*13560	10180	*9790	6830	*8170	4950	*6650	4010	8.61
	lb			*29890	22440	*21580	15060	*18010	10910	*14660	8840	(28.3)
1.5 m (5 ft)	kg					*10990	6480	8210	4770	6640	3890	8.65
	lb					*24230	14290	18100	10520	14640	8580	(28.4)
Ground Line	kg			*16130	9400	11280	6280	8080	4650	6840	3980	8.42
	lb			*35560	20720	24870	13850	17810	10250	15080	8770	(27.6)
-1.5 m (-5 ft)	kg	*10890	*10890	*15780	9410	11220	6230	8050	4630	7490	4340	7.90
	lb	*24010	*24010	*34790	20750	24740	13730	17750	10210	16510	9570	(25.9)
-3.0 m (-10 ft)	kg	*19890	18990	*14600	9570	*11030	6320			8990	5170	7.02
	lb	*43850	41870	*32190	21100	*24320	13930			19820	11400	(23.0)
-4.5 m (-15 ft)	kg	*16160	*16160	*11970	9920					*9240	7290	5.60
	lb	*35630	*35630	*26390	21870					*20370	16070	(18.4)















LIFTING CAPACITY

HX300 L















 Rating over-front  Rating over-side or 360 degrees

HX300 NL

6.25 m (20' 6") boom; 3.05 m (10' 0") arm equipped with 1.27 m³ (SAE heaped) bucket and 600 mm (24") triple grouser shoes.

Load point height m (ft)	Load radius												At max. reach		
	1.5 m (5 ft)		3.0 m (10 ft)		4.5 m (15 ft)		6.0 m (20 ft)		7.5 m (25 ft)		9.0 m (30 ft)		Capacity	Reach	
															m (ft)
7.5 m (25 ft)	kg												*4420	*4420	7.38
	lb												*9740	*9740	(24.2)
6.0 m (20 ft)	kg								*6510	5330			*4230	*4230	8.30
	lb								*14350	11750			*9330	*9330	(27.2)
4.5 m (15 ft)	kg				*9480	*9480	*7790	7320	*7010	5170			*4220	3910	8.86
	lb				*20900	*20900	*17170	16140	*15450	11400			*9300	8620	(29.1)
3.0 m (10 ft)	kg				*12540	10370	*9240	6870	*7750	4950	*5510	3720	*4360	3620	9.14
	lb				*27650	22860	*20370	15150	*17090	10910	*12150	8200	*9610	7980	(30.0)
1.5 m (5 ft)	kg				*14940	9640	*10580	6480	8190	4740	*6210	3630	*4660	3520	9.17
	lb				*32940	21250	*23320	14290	18060	10450	*13690	8000	*10270	7760	(30.1)
Ground Line	kg				*15980	9320	11240	6230	8020	4590			*5180	3600	8.94
	lb				*35230	20550	24780	13730	17680	10120			*11420	7940	(29.3)
-1.5 m (-5 ft)	kg	*7670	*7670	*11120	*11120	*15990	9270	11120	6130	7950	4530		*6070	3880	8.44
	lb	*16910	*16910	*24520	*24520	*35250	20440	24520	13510	17530	9990		*13380	8550	(27.7)
-3.0 m (-10 ft)	kg	*13120	*13120	*17920	*17920	*15130	9370	11170	6180	8030	4600		*7790	4520	7.61
	lb	*28920	*28920	*39510	*39510	*33360	20660	24630	13620	17700	10140		*17170	9960	(25.0)
-4.5 m (-15 ft)	kg			*18140	*18140	*13070	9660	*9580	6410				*8830	6000	6.32
	lb			*39990	*39990	*28810	21300	*21120	14130				*19470	13230	(20.7)

6.25 m (20' 6") boom; 3.75 m (12' 4") arm equipped with 1.27 m³ (SAE heaped) bucket and 600 mm (24") triple grouser shoes.

Load point height m (ft)	Load radius												At max. reach			
	1.5 m (5 ft)		3.0 m (10 ft)		4.5 m (15 ft)		6.0 m (20 ft)		7.5 m (25 ft)		9.0 m (30 ft)		Capacity	Reach		
															m (ft)	
7.5 m (25 ft)	kg								*5040	*5040			*3520	*3520	8.08	
	lb								*11110	*11110			*7760	*7760	(26.5)	
6.0 m (20 ft)	kg								*5710	5450			*3390	*3390	8.93	
	lb								*12590	12020			*7470	*7470	(29.3)	
4.5 m (15 ft)	kg						*6790	*6790	*6280	5270	*5140	3870	*3390	*3390	9.46	
	lb						*14970	*14970	*13850	11620	*11330	8530	*7470	*7470	(31.0)	
3.0 m (10 ft)	kg				*10810	10800	*8290	7040	*7090	5020	6370	3750	*3500	3270	9.74	
	lb				*23830	23810	*18280	15520	*15630	11070	14040	8270	*7720	7210	(31.9)	
1.5 m (5 ft)	kg				*13610	9890	*9790	6580	*7940	4770	6230	3620	*3730	3180	9.77	
	lb				*30000	21800	*21580	14510	*17500	10520	13730	7980	*8220	7010	(32.1)	
Ground Line	kg			*6790	*6790	*15290	9370	*10930	6250	8010	4580	6110	3520	*4110	3210	9.57
	lb			*14970	*14970	*33710	20660	*24100	13780	17660	10100	13470	7760	*9060	7080	(31.4)
-1.5 m (-5 ft)	kg	*6950	*6950	*10490	*10490	*15870	9180	11070	6080	7880	4460	*5730	3470	*4740	3420	9.11
	lb	*15320	*15320	*23130	*23130	*34990	20240	24410	13400	17370	9830	*12630	7650	*10450	7540	(29.9)
-3.0 m (-10 ft)	kg	*10970	*10970	*15340	*15340	*15540	9190	11040	6050	7870	4450			*5860	3870	8.36
	lb	*24180	*24180	*33820	*33820	*34260	20260	24340	13340	17350	9810			*12920	8530	(27.4)
-4.5 m (-15 ft)	kg	*15830	*15830	*20350	18580	*14200	9380	*10570	6170					*8250	4830	7.22
	lb	*34900	*34900	*44860	40960	*31310	20680	*23300	13600					*18190	10650	(23.7)

1. Lifting capacity are based on SAE J1097 and ISO 10567.



2. Lifting capacity of the HX series does not exceed 75% of tipping load with the machine on firm, level ground or 87% of full hydraulic capacity.

3. The load point is a hook located on the back of the bucket.

4. (*) indicates load limited by hydraulic capacity.

















LIFTING CAPACITY

HX300 L

 Rating over-front  Rating over-side or 360 degrees











HX300 L LONG REACH

10.2 m (33' 6") boom; 7.85 m (25' 9") arm equipped with 0.52 m³ (SAE heaped) bucket and 800 mm (32") triple grouser shoes.

Load point height m (ft)	Load radius												At max. reach					
	7 m (23.0 ft)		8.5 m (27.9 ft)		10 m (32.8 ft)		11.5 m (37.7 ft)		13 m (42.7 ft)		14.5 m (47.6 ft)		16 m (52.5 ft)		Capacity	Reach		
																	m (ft)	
12.4 m (40.7 ft)	kg															*780	*780	13.80
	lb															*1720	*1720	(45.3)
10.9 m (35.8 ft)	kg											*940	*940			*750	*750	14.82
	lb											*2070	*2070			*1650	*1650	(48.6)
9.4 m (30.8 ft)	kg											*1270	*1270			*730	*730	15.63
	lb											*2800	*2800			*1610	*1610	(51.3)
7.9 m (25.9 ft)	kg							*1740	*1740			*1500	*1500	*900	*900	*720	*720	16.25
	lb							*3840	*3840			*3310	*3310	*1980	*1980	*1590	*1590	(53.3)
6.4 m (21.0 ft)	kg							*1940	*1940	*1700	*1700	*1190	*1190	*730	*730	*730	*730	16.72
	lb							*4280	*4280	*3750	*3750	*2620	*2620	*1610	*1610	*1610	*1610	(54.9)
4.9 m (16.1 ft)	kg						*2390	*2390	*2200	*2200	*1910	*1910	*1400	*1400	*750	*750	*750	17.04
	lb						*5270	*5270	*4850	*4850	*4210	*4210	*3090	*3090	*1650	*1650	*1650	(55.9)
3.4 m (11.2 ft)	kg			*3960	*3960	*3400	*3400	*2950	*2950	*2570	*2570	*2160	*2160	*1590	*1590	*770	*770	17.23
	lb			*8730	*8730	*7500	*7500	*6500	*6500	*5670	*5670	*4760	*4760	*3510	*3510	*1700	*1700	(56.5)
1.9 m (6.2 ft)	kg	*5730	*5730	*4660	*4660	*3990	*3990	*3550	3270	*3070	2680	*2440	2220	*1740	*1740	*820	*820	17.28
	lb	*12630	*12630	*10270	*10270	*8800	*8800	*7830	7210	*6770	5910	*5380	4890	*3840	*3840	*1810	*1810	(56.7)
0.4 m (1.3 ft)	kg	*6680	6100	*5310	4730	*4450	3780	*3890	3080	*3490	2550	*2760	2120	*1850	1780	*870	*870	17.20
	lb	*14730	13450	*11710	10430	*9810	8330	*8580	6790	*7690	5620	*6080	4670	*4080	3920	*1920	*1920	(56.4)
-1.1 m (-3.6 ft)	kg	*7420	5680	*5860	4420	*4870	3550	*4200	2920	*3720	2430	*3050	2040	*1880	1720	*950	*950	16.98
	lb	*16360	12520	*12920	9740	*10740	7830	*9260	6440	*8200	5360	*6720	4500	*4140	3790	*2090	*2090	(55.7)
-2.6 m (-8.5 ft)	kg	*7950	5400	*6290	4190	*5210	3380	*4460	2790	3810	2330	*3240	1970	*1750	1680	*1050	*1050	16.63
	lb	*17530	11900	*13870	9240	*11490	7450	*9830	6150	8400	5140	*7140	4340	*3860	3700	*2310	*2310	(54.6)
-4.1 m (-13.5 ft)	kg	*8260	5250	*6590	4060	5370	3260	4430	2690	3740	2260	3210	1930	*1350	*1350	*1180	*1180	16.12
	lb	*18210	11570	*14530	8950	11840	7190	9770	5930	8250	4980	7080	4250	*2980	*2980	*2600	*2600	(52.9)
-5.6 m (-18.4 ft)	kg	*8390	5190	6640	3990	5300	3200	4380	2640	3700	2230	*2790	1910			*1360	*1360	15.46
	lb	*18500	11440	14640	8800	11680	7050	9660	5820	8160	4920	*6150	4210			*3000	*3000	(50.7)
-7.1 m (-23.3 ft)	kg	*8340	5210	6640	3980	5290	3190	4370	2640	3710	2230	*1810	*1810			*1620	*1620	14.61
	lb	*18390	11490	14640	8770	11660	7030	9630	5820	8180	4920	*3990	*3990			*3570	*3570	(47.9)
-8.6 m (-28.2 ft)	kg	*8090	5300	*6590	4040	5330	3230	4410	2680	*3260	2290					*2030	*2030	13.53
	lb	*17840	11680	*14530	8910	11750	7120	9720	5910	*7190	5050					*4480	*4480	(44.4)
-10.1 m (-33.1 ft)	kg	*7590	5460	*6220	4160	*5180	3330	*4330	2780							*2750	2600	12.18
	lb	*16730	12040	*13710	9170	*11420	7340	*9550	6130							*6060	5730	(40.0)
-11.6 m (-38.1 ft)	kg	*6740	5700	*5510	4360	*4480	3520									*4200	3350	10.44
	lb	*14860	12570	*12150	9610	*9880	7760									*9260	7390	(34.2)

HX300 L HIGH WALKER

6.25 m (20' 6") boom; 2.10 m (6' 11") arm equipped with 1.27 m³ (SAE heaped) bucket and 600 mm (24") triple grouser shoes.

Load point height m (ft)	Load radius								At max. reach			
	3.0 m (10 ft)		4.5 m (15 ft)		6.0 m (20 ft)		7.5 m (25 ft)		Capacity	Reach		
											m (ft)	
7.5 m (25 ft)	kg					*7620	*7620			*7860	*7860	6.56
	lb					*16800	*16800			*17330	*17330	(21.5)
6.0 m (20 ft)	kg					*8010	*8010	*7770	6890	*7790	6850	7.53
	lb					*17660	*17660	*17130	15190	*17170	15100	(24.7)
4.5 m (15 ft)	kg					*9110	*9110	*7990	6790	*7880	6010	8.11
	lb					*20080	*20080	*17610	14970	*17370	13250	(26.6)
3.0 m (10 ft)	kg					*10410	9090	*8570	6610	7930	5620	8.38
	lb					*22950	20040	*18890	14570	17480	12390	(27.5)
1.5 m (5 ft)	kg					*11420	8790	*9110	6450	7860	5550	8.37
	lb					*25180	19380	*20080	14220	17330	12240	(27.4)
Ground Line	kg					*11860	8650	9120	6370	8230	5790	8.08
	lb					*26150	19070	20110	14040	18140	12760	(26.5)
-1.5 m (-5 ft)	kg			*15320	13370	*11600	8660			*8890	6470	7.47
	lb			*33770	29480	*25570	19090			*19600	14260	(24.5)
-3.0 m (-10 ft)	kg	*17960	*17960	*13650	13610	*10240	8850			*9070	8030	6.47
	lb	*39590	*39590	*30090	30000	*22580	19510			*20000	17700	(21.2)
-4.5 m (-15 ft)	kg			*9580	*9580							
	lb			*21120	*21120							

1. Lifting capacity are based on SAE J1097 and ISO 10567.

2. Lifting capacity of the HX series does not exceed 75% of tipping load with the machine on firm, level ground or 87% of full hydraulic capacity.

3. The load point is a hook located on the back of the bucket.

4. (*) indicates load limited by hydraulic capacity.

LIFTING CAPACITY

HX300 L

Rating over-front Rating over-side or 360 degrees

HX300 L HIGH WALKER

6.25 m (20' 6") boom; 2.50 m (8' 2") arm equipped with 1.27 m³ (SAE heaped) bucket and 600 mm (24") triple grouser shoes.

Load point height m (ft)	Load radius								At max. reach		Reach m (ft)	
	3.0 m (10 ft)		4.5 m (15 ft)		6.0 m (20 ft)		7.5 m (25 ft)		Capacity			
7.5 m (25 ft)	kg					*6980	*6980			*6690	*6690	6.89
	lb					*15390	*15390			*14750	*14750	(22.6)
6.0 m (20 ft)	kg					*7490	*7490	*7190	6970	*6420	*6420	7.82
	lb					*16510	*16510	*15850	15370	*14150	*14150	(25.7)
4.5 m (15 ft)	kg		*11050	*11050		*8640	*8640	*7600	6830	*6440	5730	8.38
	lb		*24360	*24360		*19050	*19050	*16760	15060	*14200	12630	(27.5)
3.0 m (10 ft)	kg					*10000	9140	*8270	6620	*6700	5360	8.64
	lb					*22050	20150	*18230	14590	*14770	11820	(28.3)
1.5 m (5 ft)	kg		*13480	13350		*11140	8800	*8890	6440	*7230	5290	8.63
	lb		*29720	29430		*24560	19400	*19600	14200	*15940	11660	(28.3)
Ground Line	kg		*16080	13200		*11730	8620	9070	6330	7800	5480	8.35
	lb		*35450	29100		*25860	19000	20000	13960	17200	12080	(27.4)
-1.5 m (-5 ft)	kg	*12560	*12560	*15600	13250	*11680	8590	9080	6330	8650	6060	7.77
	lb	*27690	*27690	*34390	29210	*25750	18940	20020	13960	19070	13360	(25.5)
-3.0 m (-10 ft)	kg	*19340	*19340	*14230	13450	*10720	8720			*9050	7360	6.81
	lb	*42640	*42640	*31370	29650	*23630	19220			*19950	16230	(22.3)
-4.5 m (-15 ft)	kg	*15100	*15100	*11130	*11130					*9180	*9180	5.26
	lb	*33290	*33290	*24540	*24540					*20240	*20240	(17.2)

6.25 m (20' 6") boom; 3.05 m (10' 0") arm equipped with 1.27 m³ (SAE heaped) bucket and 600 mm (24") triple grouser shoes.

Load point height m (ft)	Load radius								At max. reach		Reach m (ft)					
	1.5 m (5 ft)		3.0 m (10 ft)		4.5 m (15 ft)		6.0 m (20 ft)		7.5 m (25 ft)			9.0 m (30 ft)				
7.5 m (25 ft)	kg									*4470	*4470		*4360	*4360	7.52	
	lb									*9850	*9850		*9610	*9610	(24.7)	
6.0 m (20 ft)	kg									*6530	*6530		*4210	*4210	8.38	
	lb									*14400	*14400		*9280	*9280	(27.5)	
4.5 m (15 ft)	kg			*9830	*9830	*7940	*7940			*7070	6870		*4220	*4220	8.90	
	lb			*21670	*21670	*17500	*17500			*15590	15150		*9300	*9300	(29.2)	
3.0 m (10 ft)	kg			*12850	*12850	*9390	9210			*7820	6640	*5540	5040	*4380	*4380	9.14
	lb			*28330	*28330	*20700	20300			*17240	14640	*12210	11110	*9660	*9660	(30.0)
1.5 m (5 ft)	kg			*15040	13430	*10670	8820			*8550	6420	*5980	4940	*4700	*4700	9.13
	lb			*33160	29610	*23520	19440			*18850	14150	*13180	10890	*10360	*10360	(30.0)
Ground Line	kg			*15910	13140	*11480	8580			9020	6280			*5260	4980	8.87
	lb			*35080	28970	*25310	18920			19890	13850			*11600	10980	(29.1)
-1.5 m (-5 ft)	kg	*8460	*8460	*12060	*12060	*15810	13110	*11680	8500	8970	6230			*6230	5430	8.33
	lb	*18650	*18650	*26590	*26590	*34860	28900	*25750	18740	19780	13730			*13730	11970	(27.3)
-3.0 m (-10 ft)	kg	*13970	*13970	*19190	*19190	*14830	13250	*11120	8560					*8140	6400	7.44
	lb	*30800	*30800	*42310	*42310	*32690	29210	*24520	18870					*17950	14110	(24.4)
-4.5 m (-15 ft)	kg			*17350	*17350	*12530	*12530	*8990	8860					*8840	8750	6.06
	lb			*38250	*38250	*27620	*27620	*19820	19530					*19490	19290	(19.9)

6.25 m (20' 6") boom; 3.75 m (12' 4") arm equipped with 1.27 m³ (SAE heaped) bucket and 600 mm (24") triple grouser shoes.

Load point height m (ft)	Load radius								At max. reach		Reach m (ft)					
	1.5 m (5 ft)		3.0 m (10 ft)		4.5 m (15 ft)		6.0 m (20 ft)		7.5 m (25 ft)			9.0 m (30 ft)				
7.5 m (25 ft)	kg									*5310	*5310		*3470	*3470	8.26	
	lb									*11710	*11710		*7650	*7650	(27.1)	
6.0 m (20 ft)	kg									*5760	*5760	*3580	*3580	*3360	*3360	9.05
	lb									*12700	*12700	*7890	*7890	*7410	*7410	(29.7)
4.5 m (15 ft)	kg					*7020	*7020	*6390	*6390	*5370	5180			*3380	*3380	9.53
	lb					*15480	*15480	*14090	*14090	*11840	11420			*7450	*7450	(31.3)
3.0 m (10 ft)	kg			*11350	*11350	*8550	*8550	*7220	6690	*6530	5050			*3510	*3510	9.76
	lb			*25020	*25020	*18850	*18850	*15920	14750	*14400	11130			*7740	*7740	(32.0)
1.5 m (5 ft)	kg			*13980	13630	*10000	8890	*8060	6430	*6990	4920			*3760	*3760	9.75
	lb			*30820	30050	*22050	19600	*17770	14180	*15410	10850			*8290	*8290	(32.0)
Ground Line	kg			*7380	*7380	*15440	13140	*11060	8570	*8730	6240			*4180	*4180	9.51
	lb			*16270	*16270	*34040	28970	*24380	18890	*19250	13760			*9220	*9220	(31.2)
-1.5 m (-5 ft)	kg	*7640	*7640	*11270	*11270	*15840	12980	*11550	8410	8880	6140			*4870	4790	9.00
	lb	*16840	*16840	*24850	*24850	*34920	28620	*25460	18540	19580	13540			*10740	10560	(29.5)
-3.0 m (-10 ft)	kg	*11750	*11750	*16400	*16400	*15340	13030	*11380	8410	*8830	6150			*6140	5490	8.19
	lb	*25900	*25900	*36160	*36160	*33820	28730	*25090	18540	*19470	13560			*13540	12100	(26.9)
-4.5 m (-15 ft)	kg	*16870	*16870	*19650	*19650	*13760	13280	*10210	8580					*8320	7000	6.96
	lb	*37190	*37190	*43320	*43320	*30340	29280	*22510	18920					*18340	15430	(22.8)

1. Lifting capacity are based on SAE J1097 and ISO 10567.

2. Lifting capacity of the HX series does not exceed 75% of tipping load with the machine on firm, level ground or 87% of full hydraulic capacity.

3. The load point is a hook located on the back of the bucket.

4. (*) indicates load limited by hydraulic capacity.













LIFTING CAPACITY

HX300 L













 Rating over-front  Rating over-side or 360 degrees

HX300 L 2-PIECE BOOM













6.25 m (20' 6") 2-piece boom; 2.10 m (6' 11") arm equipped with 1.27 m³ (SAE heaped) bucket and 600 mm (24") triple grouser shoes.

Load point height m (ft)	Load radius										At max. reach			
	3.0 m (10 ft)		4.5 m (15 ft)		6.0 m (20 ft)		7.5 m (25 ft)		9.0 m (30 ft)		Capacity	Reach		
													m (ft)	
9.0 m (30 ft)	kg			*12270	*12270							*11940	*11940	4.58
	lb			*27050	*27050							*26320	*26320	(15.0)
7.5 m (25 ft)	kg			*11390	*11390	*9440	*9440					*9270	8880	6.35
	lb			*25110	*25110	*20810	*20810					*20440	19580	(20.8)
6.0 m (20 ft)	kg			*12450	*12450	*9540	*9540					*8140	6890	7.41
	lb			*27450	*27450	*21030	*21030					*17950	15190	(24.3)
4.5 m (15 ft)	kg					*10460	9350	*8100	6690			*7640	5960	8.05
	lb					*23060	20610	*17860	14750			*16840	13140	(26.4)
3.0 m (10 ft)	kg					*12000	8910	*8540	6510			*7520	5520	8.38
	lb					*26460	19640	*18830	14350			*16580	12170	(27.5)
1.5 m (5 ft)	kg					13540	8580	*9090	6340			*7690	5410	8.42
	lb					29850	18920	*20040	13980			*16950	11930	(27.6)
Ground Line	kg					13360	8410	*9510	6240			*8200	5580	8.19
	lb					29450	18540	*20970	13760			*18080	12300	(26.9)
-1.5 m (-5 ft)	kg			*14820	12810	*11970	8410	*8830	6280			*8300	6140	7.66
	lb			*32670	28240	*26390	18540	*19470	13850			*18300	13540	(25.1)
-3.0 m (-10 ft)	kg					*9040	8590							
	lb					*19930	18940							

6.25 m (20' 6") 2-piece boom; 2.50 m (8' 2") arm equipped with 1.27 m³ (SAE heaped) bucket and 600 mm (24") triple grouser shoes.

Load point height m (ft)	Load radius										At max. reach			
	3.0 m (10 ft)		4.5 m (15 ft)		6.0 m (20 ft)		7.5 m (25 ft)		9.0 m (30 ft)		Capacity	Reach		
													m (ft)	
9.0 m (30 ft)	kg			*9800	*9800							*9000	*9000	5.09
	lb			*21610	*21610							*19840	*19840	(16.7)
7.5 m (25 ft)	kg			*9870	*9870	*8870	*8870					*7750	*7750	6.73
	lb			*21760	*21760	*19550	*19550					*17090	*17090	(22.1)
6.0 m (20 ft)	kg	*11920	*11920	*11130	*11130	*9100	*9100	*7570	6860			*7290	6500	7.73
	lb	*26280	*26280	*24540	*24540	*20060	*20060	*16690	15120			*16070	14330	(25.4)
4.5 m (15 ft)	kg			*14530	*14530	*9990	9430	*7780	6730			*7040	5670	8.35
	lb			*32030	*32030	*22020	20790	*17150	14840			*15520	12500	(27.4)
3.0 m (10 ft)	kg					*11470	8970	*8260	6520			*6960	5260	8.67
	lb					*25290	19780	*18210	14370			*15340	11600	(28.4)
1.5 m (5 ft)	kg					*13240	8590	*8850	6330			*7140	5140	8.71
	lb					*29190	18940	*19510	13960			*15740	11330	(28.6)
Ground Line	kg			*17730	12640	13330	8380	*9350	6200			*7460	5270	8.48
	lb			*39090	27870	29390	18470	*20610	13670			*16450	11620	(27.8)
-1.5 m (-5 ft)	kg			*15730	12680	*12400	8340	*9480	6190			*8400	5750	7.97
	lb			*34680	27950	*27340	18390	*20900	13650			*18520	12680	(26.1)
-3.0 m (-10 ft)	kg			*12570	*12570	*9980	8460					*7450	6810	7.10
	lb			*27710	*27710	*22000	18650					*16420	15010	(23.3)

6.25 m (20' 6") 2-piece boom; 3.05 m (10' 0") arm equipped with 1.27 m³ (SAE heaped) bucket and 600 mm (24") triple grouser shoes.

Load point height m (ft)	Load radius										At max. reach			
	3.0 m (10 ft)		4.5 m (15 ft)		6.0 m (20 ft)		7.5 m (25 ft)		9.0 m (30 ft)		Capacity	Reach		
													m (ft)	
9.0 m (30 ft)	kg			*8820	*8820	*5960	*5960					*5620	*5620	6.06
	lb			*19440	*19440	*13140	*13140					*12390	*12390	(19.9)
7.5 m (25 ft)	kg			*8660	*8660	*8280	*8280					*4990	*4990	7.46
	lb			*19090	*19090	*18250	*18250					*11000	*11000	(24.5)
6.0 m (20 ft)	kg			*9630	*9630	*8600	*8600	*7100	6940			*4740	*4740	8.37
	lb			*21230	*21230	*18960	*18960	*15650	15300			*10450	*10450	(27.5)
4.5 m (15 ft)	kg			*13240	*13240	*9450	*9450	*7410	6770			*4690	*4690	8.93
	lb			*29190	*29190	*20830	*20830	*16340	14930			*10340	*10340	(29.3)
3.0 m (10 ft)	kg			*17310	13700	*10880	9020	*7930	6530	*6360	4950	*4810	4770	9.21
	lb			*38160	30200	*23990	19890	*17480	14400	*14020	10910	*10600	10520	(30.2)
1.5 m (5 ft)	kg			*18670	12890	*12670	8590	*8570	6300	*6580	4850	*5090	4670	9.24
	lb			*41160	28420	*27930	18940	*18890	13890	*14510	10690	*11220	10300	(30.3)
Ground Line	kg			*18290	12560	13280	8330	*9140	6140	*5760	4800	*5590	4790	9.01
	lb			*40320	27690	29280	18360	*20150	13540	*12700	10580	*12320	10560	(29.6)
-1.5 m (-5 ft)	kg	*12160	*12160	*16670	12520	*12820	8230	9440	6080			*6450	5170	8.51
	lb	*26810	*26810	*36750	27600	*28260	18140	20810	13400			*14220	11400	(27.9)
-3.0 m (-10 ft)	kg			*13870	12670	*10860	8300	*7840	6180			*7310	6000	7.69
	lb			*30580	27930	*23940	18300	*17280	13620			*16120	13230	(25.2)

1. Lifting capacity are based on SAE J1097 and ISO 10567.

2. Lifting capacity of the HX series does not exceed 75% of tipping load with the machine on firm, level ground or 87% of full hydraulic capacity.

3. The load point is a hook located on the back of the bucket.

4. (*) indicates load limited by hydraulic capacity.

LIFTING CAPACITY

HX300 L

Rating over-front Rating over-side or 360 degrees

HX300 NL 2-PIECE BOOM

6.25 m (20' 6") 2-piece boom; 2.10 m (6' 11") arm equipped with 1.27 m³ (SAE heaped) bucket and 600 mm (24") triple grouser shoes.

Load point height m (ft)	Load radius										At max. reach		
	3.0 m (10 ft)		4.5 m (15 ft)		6.0 m (20 ft)		7.5 m (25 ft)		9.0 m (30 ft)		Capacity	Reach	
													m (ft)
9.0 m (30 ft)	kg		*12270	*12270							*11940	*11940	4.58
	lb		*27050	*27050							*26320	*26320	(15.0)
7.5 m (25 ft)	kg		*11390	*11390	*9440	9020					*9270	8160	6.35
	lb		*25110	*25110	*20810	19890					*20440	17990	(20.8)
6.0 m (20 ft)	kg		*12450	*12450	*9540	8920					*8140	6330	7.41
	lb		*27450	*27450	*21030	19670					*17950	13960	(24.3)
4.5 m (15 ft)	kg				*10460	8560	*8100	6140			*7640	5470	8.05
	lb				*23060	18870	*17860	13540			*16840	12060	(26.4)
3.0 m (10 ft)	kg				*12000	8130	*8540	5960			*7520	5060	8.38
	lb				*26460	17920	*18830	13140			*16580	11160	(27.5)
1.5 m (5 ft)	kg				13470	7810	*9090	5790			*7690	4940	8.42
	lb				29700	17220	*20040	12760			*16950	10890	(27.6)
Ground Line	kg				13280	7650	*9510	5700			*8200	5100	8.19
	lb				29280	16870	*20970	12570			*18080	11240	(26.9)
-1.5 m (-5 ft)	kg		*14820	11540	*11970	7650	*8830	5740			*8300	5610	7.66
	lb		*32670	25440	*26390	16870	*19470	12650			*18300	12370	(25.1)
-3.0 m (-10 ft)	kg				*9040	7820							
	lb				*19930	17240							

6.25 m (20' 6") 2-piece boom; 2.50 m (8' 20") arm equipped with 1.27 m³ (SAE heaped) bucket and 600 mm (24") triple grouser shoes.

Load point height m (ft)	Load radius										At max. reach		
	3.0 m (10 ft)		4.5 m (15 ft)		6.0 m (20 ft)		7.5 m (25 ft)		9.0 m (30 ft)		Capacity	Reach	
													m (ft)
9.0 m (30 ft)	kg		*9800	*9800							*9000	*9000	5.09
	lb		*21610	*21610							*19840	*19840	(16.7)
7.5 m (25 ft)	kg		*9870	*9870	*8870	*8870					*7750	7540	6.73
	lb		*21760	*21760	*19550	*19550					*17090	16620	(22.1)
6.0 m (20 ft)	kg	*11920	*11920	*11130	*11130	*9100	9010	*7570	6300		*7290	5970	7.73
	lb	*26280	*26280	*24540	*24540	*20060	19860	*16690	13890		*16070	13160	(25.4)
4.5 m (15 ft)	kg		*14530	13250	*9990	8640	*7780	6180			*7040	5200	8.35
	lb		*32030	29210	*22020	19050	*17150	13620			*15520	11460	(27.4)
3.0 m (10 ft)	kg				*11470	8190	*8260	5970			*6960	4810	8.67
	lb				*25290	18060	*18210	13160			*15340	10600	(28.4)
1.5 m (5 ft)	kg				*13240	7820	*8850	5780			*7140	4690	8.71
	lb				*29190	17240	*19510	12740			*15740	10340	(28.6)
Ground Line	kg		*17730	11370	13250	7610	*9350	5660			*7460	4820	8.48
	lb		*39090	25070	29210	16780	*20610	12480			*16450	10630	(27.8)
-1.5 m (-5 ft)	kg		*15730	11410	*12400	7570	*9480	5650			*8400	5250	7.97
	lb		*34680	25150	*27340	16690	*20900	12460			*18520	11570	(26.1)
-3.0 m (-10 ft)	kg		*12570	11610	*9980	7690					*7450	6220	7.10
	lb		*27710	25600	*22000	16950					*16420	13710	(23.3)

6.25 m (20' 6") 2-piece boom; 3.05 m (10' 0") arm equipped with 1.27 m³ (SAE heaped) bucket and 600 mm (24") triple grouser shoes.

Load point height m (ft)	Load radius										At max. reach		
	3.0 m (10 ft)		4.5 m (15 ft)		6.0 m (20 ft)		7.5 m (25 ft)		9.0 m (30 ft)		Capacity	Reach	
													m (ft)
9.0 m (30 ft)	kg		*8820	*8820	*5960	*5960					*5620	*5620	6.06
	lb		*19440	*19440	*13140	*13140					*12390	*12390	(19.9)
7.5 m (25 ft)	kg		*8660	*8660	*8280	*8280					*4990	*4990	7.46
	lb		*19090	*19090	*18250	*18250					*11000	*11000	(24.5)
6.0 m (20 ft)	kg		*9630	*9630	*8600	*8600	*7100	6380			*4740	*4740	8.37
	lb		*21230	*21230	*18960	*18960	*15650	14070			*10450	*10450	(27.5)
4.5 m (15 ft)	kg		*13240	*13240	*9450	8720	*7410	6210			*4690	4670	8.93
	lb		*29190	*29190	*20830	19220	*16340	13690			*10340	10300	(29.3)
3.0 m (10 ft)	kg		*17310	12390	*10880	8240	*7930	5970	*6360	4530	*4810	4360	9.21
	lb		*38160	27320	*23990	18170	*17480	13160	*14020	9990	*10600	9610	(30.2)
1.5 m (5 ft)	kg		*18670	11600	*12670	7820	*8570	5750	*6580	4430	*5090	4270	9.24
	lb		*41160	25570	*27930	17240	*18890	12680	*14510	9770	*11220	9410	(30.3)
Ground Line	kg		*18290	11290	13200	7560	*9140	5590	*5760	4370	*5590	4370	9.01
	lb		*40320	24890	29100	16670	*20150	12320	*12700	9630	*12320	9630	(29.6)
-1.5 m (-5 ft)	kg	*12160	*12160	*16670	11250	*12820	7470	9380	5540		*6450	4710	8.51
	lb	*26810	*26810	*36750	24800	*28260	16470	20680	12210		*14220	10380	(27.9)
-3.0 m (-10 ft)	kg		*13870	11400	*10860	7540	*7840	5630			*7310	5470	7.69
	lb		*30580	25130	*23940	16620	*17280	12410			*16120	12060	(25.2)

1. Lifting capacity are based on SAE J1097 and ISO 10567.

2. Lifting capacity of the HX series does not exceed 75% of tipping load with the machine on firm, level ground or 87% of full hydraulic capacity.

3. The load point is a hook located on the back of the bucket.

4. (*) indicates load limited by hydraulic capacity.

ENGINE	STD	OPT
Cummins QSB 6.7 engine	●	
HYDRAULIC SYSTEM		
Intelligent Power Control (IPC)		
3-power mode, 2-work mode, user mode	●	
Variable Power Control	●	
Pump Flow Control	●	
Attachment Mode Flow Control		●
Engine Auto Idle	●	
Engine Auto Shutdown Control		●
Electronic Fan Control	●	
CABIN & INTERIOR		
ISO Standard cabin		
Rise-up type windshield wiper	●	
Radio / USB player	●	
Handsfree mobile phone system with USB	●	
12 volt power outlet (24V DC to 12V DC converter)	●	
Electric horn	●	
All-weather steel cab with 360° visibility	●	
Safety glass windows	●	
Sliding fold-in front window	●	
Sliding side window (LH)	●	
Lockable door	●	
Hot & cool box	●	
Storage compartment & Ashtray	●	
Transparent cabin roof-cover	●	
Sun visor	●	
Door and cab locks, one key	●	
Mechanical suspension seat with heater	●	
Pilot-operated slidable joystick	●	
Console box height adjust system	●	
Automatic climate control		
Air conditioner & heater	●	
Defroster	●	
Starting Aid (air grid heater) for cold weather	●	
Centralized monitoring		
8" LCD display	●	
Engine speed or Trip meter/Accel.	●	
Engine coolant temperature gauge	●	
Max power	●	
Low speed/High speed	●	
Auto idle	●	
Overload	●	
Check Engine	●	
Air cleaner clogging	●	
Indicators	●	
ECO Gauges	●	
Fuel level gauge	●	
Hyd. oil temperature gauge	●	
Fuel warmer	●	
Warnings	●	
Communication error	●	
Low battery	●	
Clock	●	
Cabin lights	●	
Cabin front window rain guard		●
Cabin roof-steel cover		●
Seat		
Adjustable air suspension seat with heater		●
Cabin FOPS/FOG (ISO/DIS 10262) Level 2		
FOPS (Falling Object Protective Structure) · ISO 3449 Level 2		●
FOG (Falling Object Guard)		●
Cabin ROPS (ISO 12117-2)		
ROPS (Roll Over Protective Structure)	●	

SAFETY	STD	OPT
Battery master switch	●	
Rearview camera	●	
AAVM (Advanced Around View Monitoring)		●
Four front working lights	●	
Travel alarm	●	
Rear work lamp		●
Beacon lamp		●
Automatic swing brake	●	
Boom holding system	●	
Arm holding system	●	
Safety lock valve for boom cylinder with overload warning device	●	
Safety lock valve for arm cylinder		●
Swing Lock System		●
Three outside rearview mirrors	●	

OTHER		
Booms		
6.25 m; 20' 6"	●	
10.2 m; 33' 6" Long reach		●
Arms		
2.1 m; 6' 11"		●
2.5 m; 8' 2"		●
3.05 m; 10' 0"	●	
3.75 m; 12' 4"		●
7.85 m; 25' 9" Long reach		●
Removable clean-out dust net for cooler	●	
Removable reservoir tank	●	
Fuel pre-filter	●	
Fuel warmer single	●	
Fuel warmer dual		●
Self-diagnostics system	●	
Hi MATE (Remote Management System)	●	
Batteries (2 x 12 V x 160 Ah)	●	
Fuel filler pump (50 l/min)	●	
Single-acting piping kit (breaker, etc.)		●
Double-acting piping kit (clamshell, etc.)	●	
Rotating Piping Kit		●
Quick coupler piping		●
Quick coupler		●
Boom floating control		●
One Pedal Straight Travel System		●
Accumulator for lowering work equipment	●	
Pattern change valve (2 patterns)		●
Tool kit		●

UNDERCARRIAGE		
Lower frame under cover (Additional)		●
Lower frame under cover (Normal)	●	
Track shoes		
Triple grouser shoes (600 mm; 24")	●	
Triple grouser shoes (700 mm; 28")		●
Triple grouser shoes (800 mm; 32")		●
Triple grouser shoes (900 mm; 36")		●
Double grouser shoes (700 mm; 28")		●
Track rail guard	●	
Full track rail guard high walker		●

SWING BEARING		
Swing bearing	●	
Swing bearing (High Walker)		●

STD = Standard
OPT = Optional

- * Standard and optional equipment may vary. Contact your Hyundai dealer for more information. The machine may vary according to International standards.
- * The photos may include attachments and optional equipment that are not available in your area.
- * Materials and specifications are subject to change without advance notice.
- * All imperial measurements rounded off to the nearest pound or inch.
- * The air conditioning system on this machine contains the fluorinated greenhouse gas refrigerant HFC-134a (Global Warming Potential = 1430). The system contains 0.7 kg of refrigerant which has a CO₂ equivalent of 1.001 metric tonne.



PLEASE CONTACT

Hyundai Construction Equipment Europe nv

Hyundailaan 4, 3980 Tessenderlo, Belgium Tel: (32) 14-56-2200 Fax: (32) 14-59-3405 www.hyundai.eu

EN - 2017.11 Rev 6